

# PHILIPS

## Xitanium

### LED driver



## Datasheet

# Xitanium FULL Prog LED Xtreme drivers

Xi FP 165W 0.2-0.7A SNLDAE 230V C170 sXt

### Xitanium FULL Prog LED Xtreme drivers

Philips Xitanium Full Programmable LED drivers are specifically designed to deliver the highest performance, protection and configurability. The portfolio offers both central and standalone dimming protocols further increasing the energy savings and CO<sub>2</sub> reductions achieved with LED lighting. The Xtreme technology ensures maximum robustness and protection combined with a very long lifetime.

In this product family Philips introduces new drivers in a compact form factor with state-of-the-art features, which offer high value for both OEM customers and end-users. The products can replace the existing programmable outdoor LED drivers and will bring significant improvement in programming, assembly into a luminaire and electrical performance.

#### Benefits

- Ultimate robustness, offering peace of mind and lower maintenance costs
- Fully programmable LED-drivers designed for the new digital and connected lighting world
- Extended diagnostics via MultiOne
- Easy to design-in, configure and install for Class I and Class II applications
- Energy savings through high efficiency and via multiple dimming options

#### Features

- High surge protection (CM/DM)
- Long lifetime and robust protection against moisture, vibration and temperature
- Configurable operating windows (AOC)
- Multiple control interfaces: DALI, LineSwitch
- Autonomous dimming via integrated DynaDimmer
- Thermal protection for driver and for module (MTP)
- Constant Light Output (CLO)
- Adjustable Start-up Time (AST)
- Adjustable Light Output (ALO)
- End-Of-Life indicator (EOL)

#### Application

- Road and street lighting
- Area lighting
- Industrial lighting

## Electrical input data

Specification item	Value	Unit	Condition
Nominal input voltage	220...240	V <sub>ac</sub>	performance range
Nominal input frequency	50...60	Hz	
Nominal input current	0.78	A	@230V @ full load
Input voltage	230	V <sub>ac</sub>	
Nominal input power	179	W	@230V @ full load
Power factor	≥ 0.99		@ full load. See graph.
Total harmonic distortion	≤ 6	%	@ full load. See graph.
Efficiency	93	%	@230V @ full load
Nominal input voltage DC	186...250	V <sub>dc</sub>	
Nominal input current DC	0.96	A	Input voltage 230 V <sub>dc</sub> , full load
Input voltage AC	198...264	V <sub>ac</sub>	Operational range
Input frequency AC	45...66	Hz	Maximum permissible range
Input voltage DC	168...275	V <sub>dc</sub>	Maximum permissible range
Standby power	0.5	W	
Isolation Input to Output	Double		

## Electrical output data

Specification item	Value	Unit	Condition
Regulation method	Constant Current		
Output voltage	100...300	V <sub>dc</sub>	
Output voltage max.	330	V	Peak voltage at open load
Output current	0.07...0.7	A	Full output current setting
Output current min programmable	200	mA	
Output current min dimming	70	mA	
Output current tolerance	± 5	%	
Output current ripple LF	≤ 4	%	Ripple = peak / average
Output power	10...165	W	Full output

## Electrical data controls input

Specification item	Value	Unit	Condition
Control method	Dynadim, DALI, AmpDim, LineSwitch		Output current amplitude dimming
Dimming range	10...100	%	DALI acc. IEC62386-101 Ed.2.0, -102 Ed. 2.0; LineSwitch: Vlow: < 160Vac Vhigh: 170 ... 264Vac

## Logistical data

Specification item	Value
Product name	Xi FP 165W 0.2-0.7A SNLDAE 230V C170 sXt
Order code	8718 696 565 742
Logistic code 12NC	9290 009 76206
EAN3	
Pieces per box	9

## Wiring & Connections

Specification item	Value	Unit	Condition
Input wire cross-section	0.5...2.5	mm <sup>2</sup>	WAGO804, solid / stranded wire
	12...20	AWG	WAGO804, solid / stranded wire
Input wire strip length	10...11	mm	
Output wire cross-section	0.3...1.5	mm <sup>2</sup>	WAGO805, solid / stranded wire
	16...24	AWG	WAGO805, solid / stranded wire
Output wire strip length	9...10	mm	
Maximum cable length	2500	mm	Total length of wiring including LED module, one way

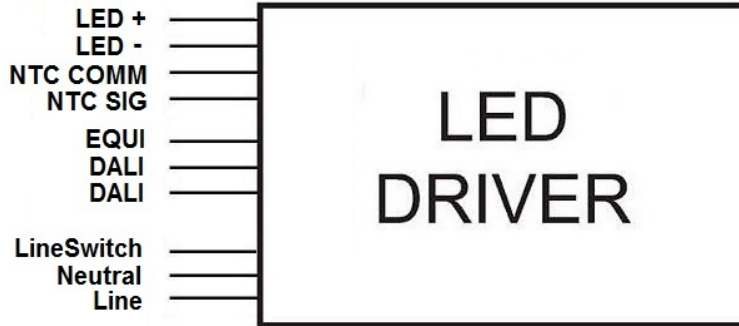

## Insulation

Insulation	Mains	EQUI	LED + NTC	LineSwitch	DALI
Mains		Double	Double	NA	Basic
EQUI	Double		Double	Double	Double
LED + NTC	Double	Double		Double	Double
LineSwitch	NA	Double	Double		Basic
DALI	Basic	Double	Double	Basic	

## Dimensions and weight

Specification item	Value	Unit	Condition
Length (A1)	170	mm	
Width (B1)	100	mm	
Height (C1)	40	mm	
Fixing hole diameter (D1)	4.5	mm	
Fixing hole distance (A2)	160	mm	
Weight	890	gram	

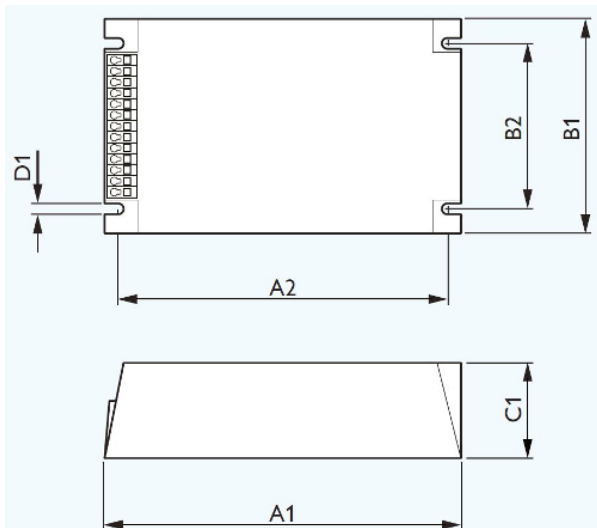

## Operational temperatures and humidity

Specification item	Value	Unit	Condition
Ambient temperature	-30...+55	°C	Higher ambient temperature allowed as long as Tcase-max is not exceeded.
Starting Ambient temperature	-30...+55	°C	
Tcase-max	90	°C	50khrs, 90% surv.
Tcase-life	80	°C	100khrs, 90% surv. Measured at T <sub>c</sub> -point
Maximum housing temperature	120	°C	In case of a failure
Relative humidity	10...90	%	Non-condensing

## Storage temperature and humidity

Specification item	Value	Unit	Condition
Ambient temperature	-30...+85	°C	
Relative humidity	5...95	%	Non-condensing

## Lifetime

Specification item	Value	Unit	Condition
Driver lifetime	100,000	hours	Measured temperature at T <sub>case</sub> -point is T <sub>case</sub> -life. Maximum failures = 10%

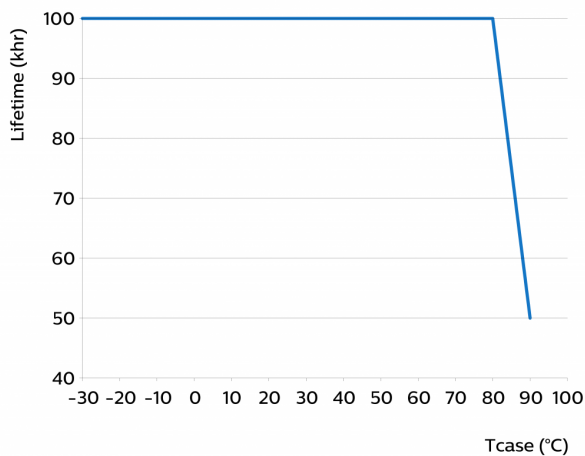

## Programmable features

Specification item	Value	Remark	Condition
Set output current (AOC)	Programmable and SimpleSet	See Design-in guide.	Default output current: ≤ 700 mA
LED module temperature derating (MTP)	Yes		
Constant Lumen Over Lifetime (CLO)	Yes		
DC emergency dimming (DCemDIM)	Yes		Default: AOC = 15%
Diagnostics	Yes		
Adjustable Light Output ALO	Yes		
Ampdim	Yes		
LineSwitch	Yes		
Adjustable Start-up Time AST	Yes		
Integrated Dynadimmer	Yes		
End Of Life indicator	Yes		

## Features

Specification item	Value	Remark	Condition
Open load protection	Yes		Automatic recovering
Short circuit protection	Yes		Automatic recovering
Over power protection	Yes		Automatic recovering
Hot wiring	No		
Suitable for fixtures with protection class	I and II		per IEC60598
Over temperature protection driver	Yes		Automatic recovery
Overheating protection	Yes		Automatic recovering

## Certificates and standards

Specification item	Value
Approval marks	CB / CE / ENEC / VDE-EMV
Ingress Protection classification	20

## Inrush current

Specification item	Value	Unit	Condition
Inrush current $I_{peak}$	58	A	Input voltage 230V
Inrush current $T_{width}$	340	$\mu$ s	Input voltage 230V, measured at 50% $I_{peak}$
Drivers / MCB 16A type B	$\leq 7$	pcs	

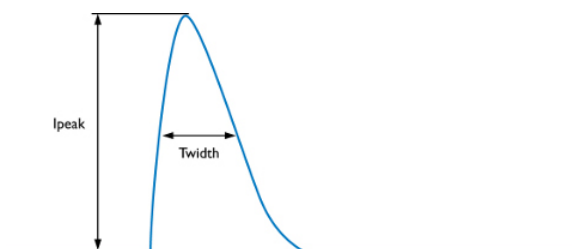

MCB	Rating	Relative number of LED drivers
B	10A	63%
B	13A	81%
B	16A	100% (stated in datasheet)
B	20A	125%
B	25A	156%
C	10A	104%
C	13A	135%
C	16A	170%
C	20A	208%
C	25A	260%

## Driver touch current

Specification item	Value	Unit	Condition
Typical touch current	0.29	mA peak	Acc. IEC61347-1. LED module contribution not included

## Surge immunity

Specification item	Value	Unit	Condition
Mains surge immunity (diff. mode)	6	kV	L-N, Ls-L, Ls-N, acc. IEC61000-4-5. 2 Ohm, 1.2/50us, 8/20us
Mains surge immunity (comm. mode)	8	kV	L/N-GND, Ls-GND, acc. IEC61000-4-5. 12 Ohm 1.2/50us, 8/20us
Control surge immunity (diff. mode)	0.9	kV	DALI, acc. IEC61000-4-5. 2 Ohm, 1.2/50us, 8/20us
Control surge immunity (comm. mode)	8	kV	DALI-GND, acc. IEC61000-4-5. 12 Ohm, 1.2/50us, 8/20us

## Additional information

Specification item	Value	Unit	Condition
AOC	700	mA	
LineSwitch	ON		
ALO	OFF		
CLO	100	%	
MTP	ON		
Dynadimmer	OFF		
AST	ON		
EOL	OFF		

## Graphs

### Operating window

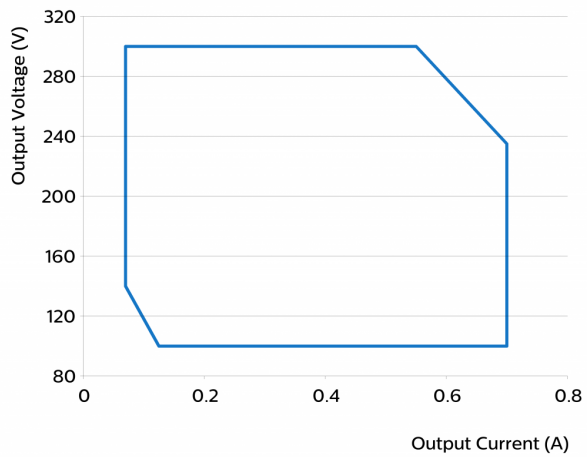

### I<sub>out</sub> versus T<sub>case</sub>

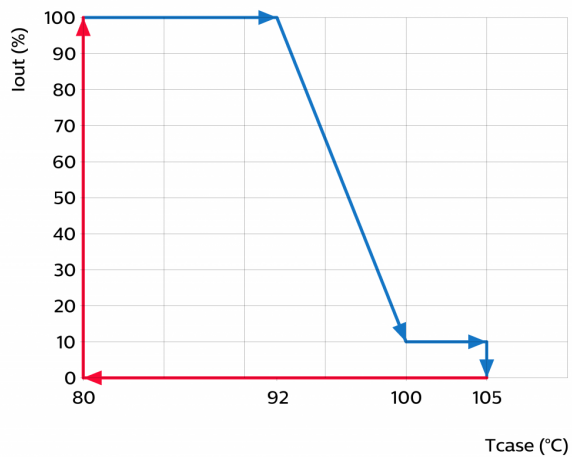

## Pout versus Vmains

---

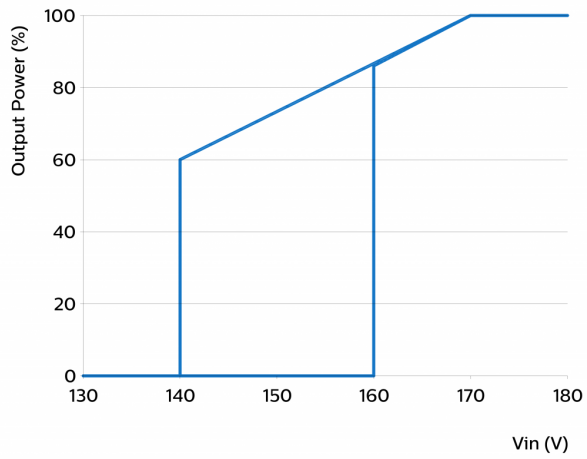

## Power factor versus output power

---

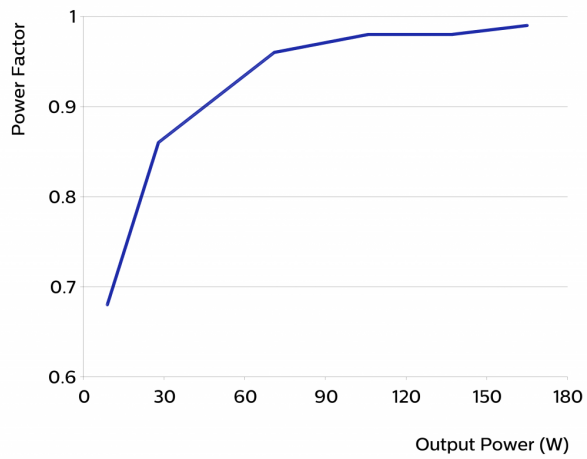

## Efficiency versus output power

---

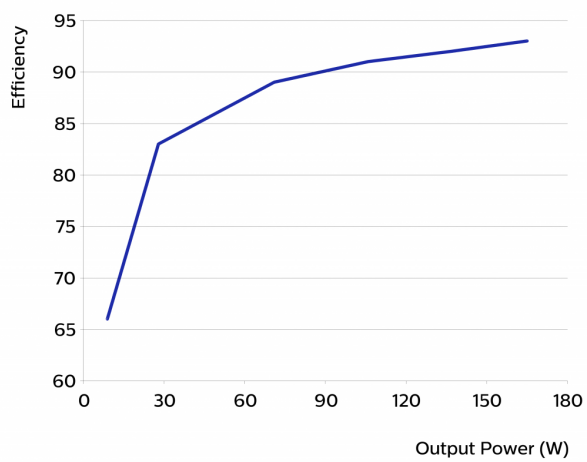

## THD versus output power

---

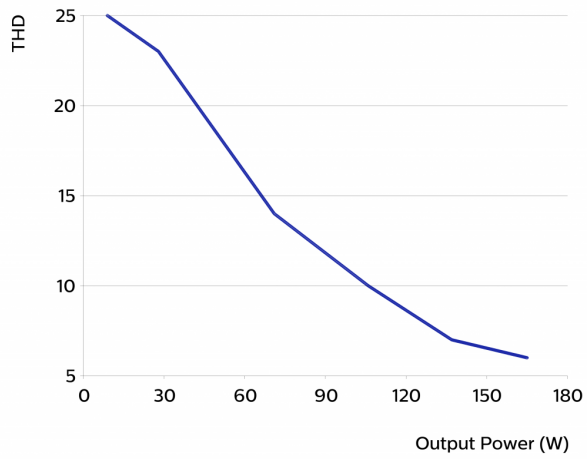

©2016 Philips Lighting B.V.

All rights reserved. Reproduction in whole or in part is prohibited without the prior written consent of the copyright owner. The information presented in this document does not form part of any quotation or contract, is believed to be accurate and reliable and may be changed without notice. No liability will be accepted by the publisher for any consequence of its use. Publication thereof does not convey nor imply any license under patent- or other industrial or intellectual property rights. Data subject to change.

Date of release: March 30, 2016

[www.philips.com/technology](http://www.philips.com/technology)